



CASE STUDIES

Contents

1. CASE STUDIES ON DESIGN

- ZATPAT House, Maharashtra, India
- J57, China
- 2-storey building, Kochi, India
- 25-storey student residence, Wolverhampton, UK
- Meridian First Light House, USA
- One9, Melbourne

2. CASE STUDIES ON TECHNOLOGY

- Prefabricated Sandwich Panel System
- Monolithic Concrete Tunnel Formwork
- Precast Concrete Construction System
- Precast Concrete Construction - 3D Volumetric
- Light Gauge Steel System
- PVC Stay in Place Formwork

3. CASE STUDIES ON PROCESSES & SOFTWARE

A. Processes

- Volumetric Construction
- Hybrid Construction
- Panelized Construction
- Sub-Assemblies and Accessories Systems
- Tilting Moulds

B. Software

- Tekla
- DreamPlan
- Parabuild
-

3. CASE STUDIES ON MATERIALS

- Structural Insulated Panels
- Rapid Hardening Cement
- Quick Setting Cement

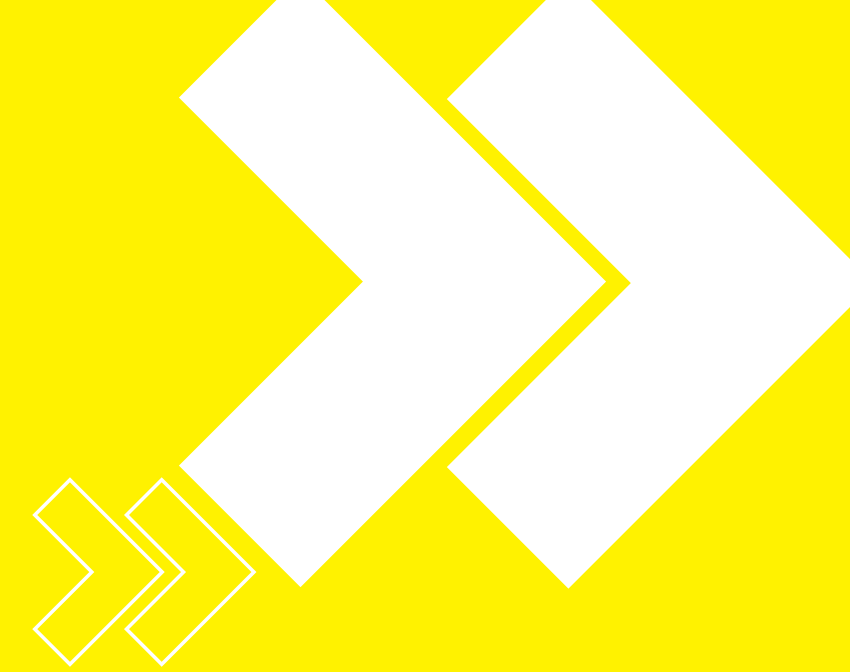

/ CASE STUDIES ON DESIGN

ZATPAT HOUSE, MAHARASHTRA, INDIA

J57, CHINA

2-STOREY BUILDING, KOCHI, INDIA

25-STOREY STUDENT RESIDENCE, WOLVERHAMPTON, UK

MERIDIAN FIRST LIGHT HOUSE, USA

ONE9, MELBOURNE

ZATPAT House, Maharashtra, India



The houses can be dismantled and re-installed anywhere, making them eco-friendly too. While they are not built with bricks and timber, yet their walls have tremendous strength owing to the chicken meshes reinforcement, making them earthquake resistant as well.

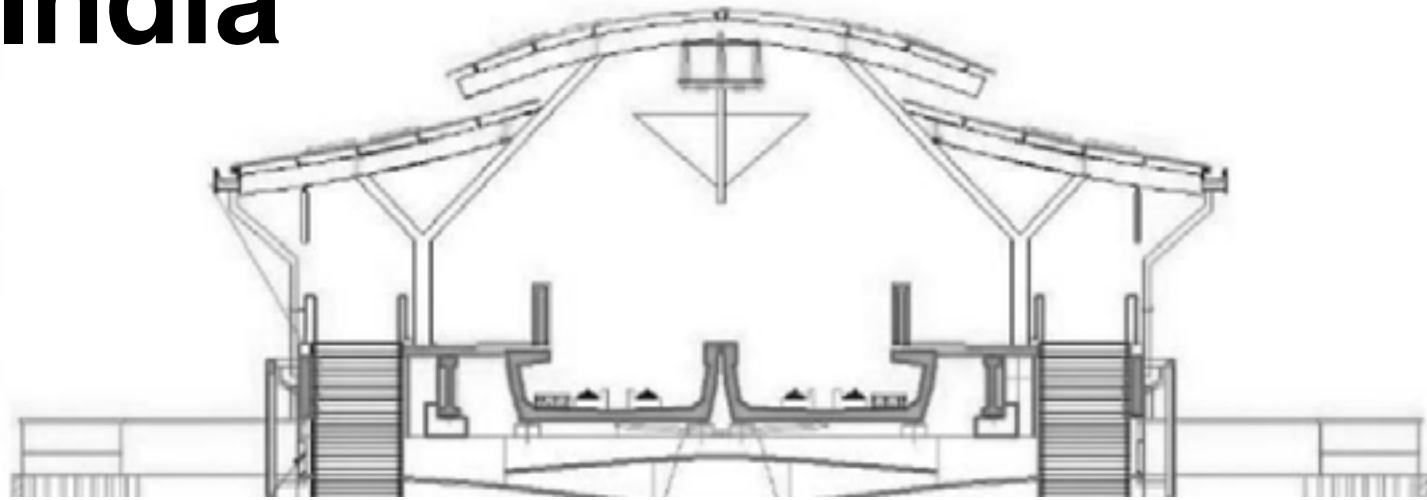

Jayant Murudkar, a 78-year-old engineer from Satara MIDC, manufactured a ZATPAT House in just a day. Assembling ferrocement components like readymade walls and readymade slabs, joint with nuts and bolts, he did away with time-consuming processes at the site. Ferrocement is a combination of cement, sand, weld mesh and chicken mesh pressed and filled with mortar. Skeletal steel in the form of 6mm/8mm bars is used for getting the form and shape to eliminate the use of formwork.

The precast ferrocement wall panels had standardized 3.5 x 2.5 meter and a thickness of 25 mm. With roofing panels of 4 x 0.6 m in size with the same thickness, the panels are ribbed so they have greater strength while being light in weight.

Inspected by the Ferrocement Society, the ZATPAT House is becoming a popular structure in

Maharashtra as it has provided immediate shelters to rehabilitate scores of families, thus making it ideal for mass housing. The houses can be dismantled and re-installed anywhere, making them eco-friendly too. While they are not built with bricks and timber, their walls have tremendous strength owing to the chicken mesh reinforcements, making them earthquake resistant as well.

Er Murudkar has a factory set-up that produces ferrocement components, manufacturing panels of 0.6 x 3 meters, that weigh about 100 kg only. A precast wall panel of 3.5 X 2.5m size weighs 750 kg only. Thickness of 25 mm is available and a 100 mm thick wall panel is manufactured using thermocol as an insulation filler.

ZATPAT House is also very affordable. If the plan dimensions of the room are 4.5 m by 3.5 m and the



Zatpat House

height is 2.5 m, the cost of a house is only Rs 1,71,000. This includes excavation, foundation concrete, masonry, door and window, one bathroom and one toilet externally attached to the room. The rate is Rs 1,010 per sq.ft.

“A little change in the type and pattern of the reinforcement, the use of fine wire meshes instead of large diameter bars, and press filling mortar either by hand, machines, or pre-casting, makes it a wonder material!” says Dr (Prof) Divekar who has designed and constructed a large number of such structures.



Know more:
<https://bit.ly/3w0ZiWk>



J57, China

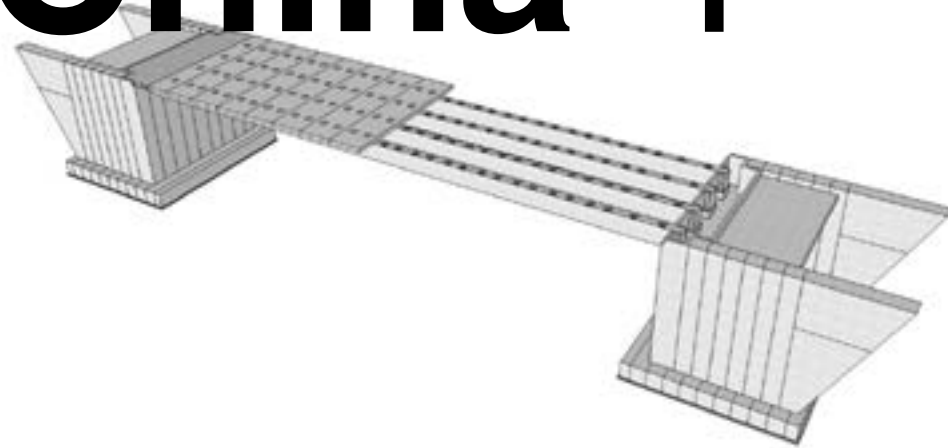

J57 is a mini prototype for the planned 220-storey Sky City. "By using modular construction, we were able to reduce the use of concrete by 15,000 trucks. With 19 atriums (each at 10 metres height), 800 apartments and office space that can accommodate 4,000 people

Modular construction Modular construction has ensured new heights get completed in record time. BROAD Group, China, has erected a 57-storey building in just 19 days. With 19 atriums (each at 10 metres height), 800 apartments and office space that can accommodate 4,000 people, J57 is a mini prototype for the planned 220-storey Sky City.

"By using modular construction, we were able to reduce the use of concrete by 15,000 trucks. Dust levels during construction were almost non-existent compared to traditional methods," Juliet Jiang, VP of BROAD Group, says.

Before J57, in 2011 the T30 Hotel, a 30-storey building, was constructed in 15 days, at a low-cost of less than \$1000/sqm.

From a sustainability and design perspective, the building is five times more energy-efficient than conventional buildings having 20-cm thermal insulation for walls, four-paned super white glass windows, 100 per cent filtered fresh air, and a combined cooling, heating and power system.



About Modular Prefabrication
<https://bit.ly/3qBBvuP>

Quality control of the module prefab process in a factory environment is one of the key factors that allows efficient cost control, as construction material waste is eliminated.

"BSB technology is an exciting part of our modular construction investment. The building costs can reach up to 30 per cent in savings, while also dramatically improving the construction quality. BSB involves standardised design, modular production, stringent product management and highly skilled workers. And at the end of the day, only one company is responsible for all quality assurances," Ms Jiang notes.

Cold galvanising anti-corrosion technology is applied to steel materials, while tight thermal insulation prevents condensation corrosion and ensures longer life spans extending to 50 years. Additionally, all steel materials can be re-used post decommissioning.

Modular construction is progressing in leaps and bounds, with 4th generation technology having newer capabilities in both technology and process.



2-storey building, Kochi, India

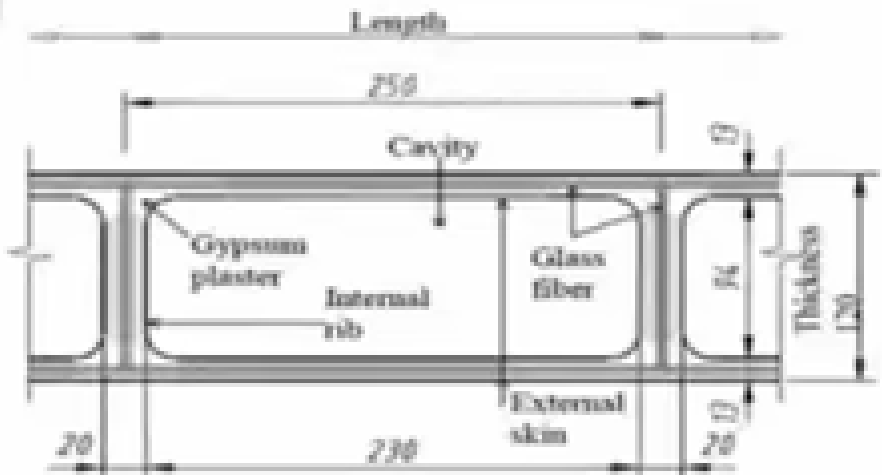
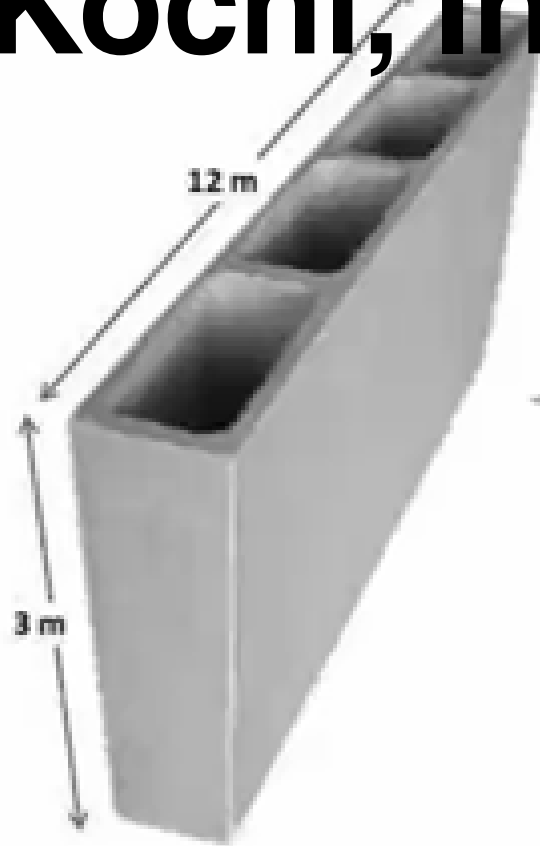

They are energy-efficient green building material with enormous potential for use as load-bearing and non-load bearing wall panels. It is suitable for the construction of both external and internal walls.

In a 2-storey building in Kochi, constructed by a Kerala based company Sheghram Nirman Pvt. Ltd., GFRG panels technique reduced the complete cost and time estimation by more than 50%, saving materials and the time taken to construct this building as against the conventional method.

The most obvious advantage of GFRG panel construction is the speed of construction on site. With a wall panel thickness of just 124mm, there is more carpet area in the built area. Eight to 10 storey buildings can be designed using GFRG panels, without the need for conventional RC beams and columns. The use of factory-made panels for all the walls, floors and staircases



gives good finishing as compared to labour intensive work for the same. Less embodied energy and carbon footprint due to the significant reduction in the use of steel, cement, sand and water, and the use of recycled industrial waste gypsum make it a more sustainable building than its conventional counterpart.

Strong and durable GFRG allows an advanced mode of construction at an affordable cost. They are energy-efficient green building materials with enormous potential for use as load-bearing and non-load bearing wall panels. They are suitable for the construction of both external and internal walls. They can also be used as intermediary floor slab/roof slabs together with Reinforced Cement Concrete (RCC) as a composite material. Not only the walls but also

the floors, sunshades, boundaries and roofs can be made using GFRG panels.

GFRG panel possesses high flexural strength, shearing strength, compressive strength, and flexibility. It has a very high level of resistance to fire, water, heat, corrosion, rot, and termites. Concrete filled with vertical reinforcement rods improves its vertical and lateral load capacities. GFRG made buildings are resistant to fire, earthquakes, and cyclones.



25 storey student residence, Wolverhampton, UK

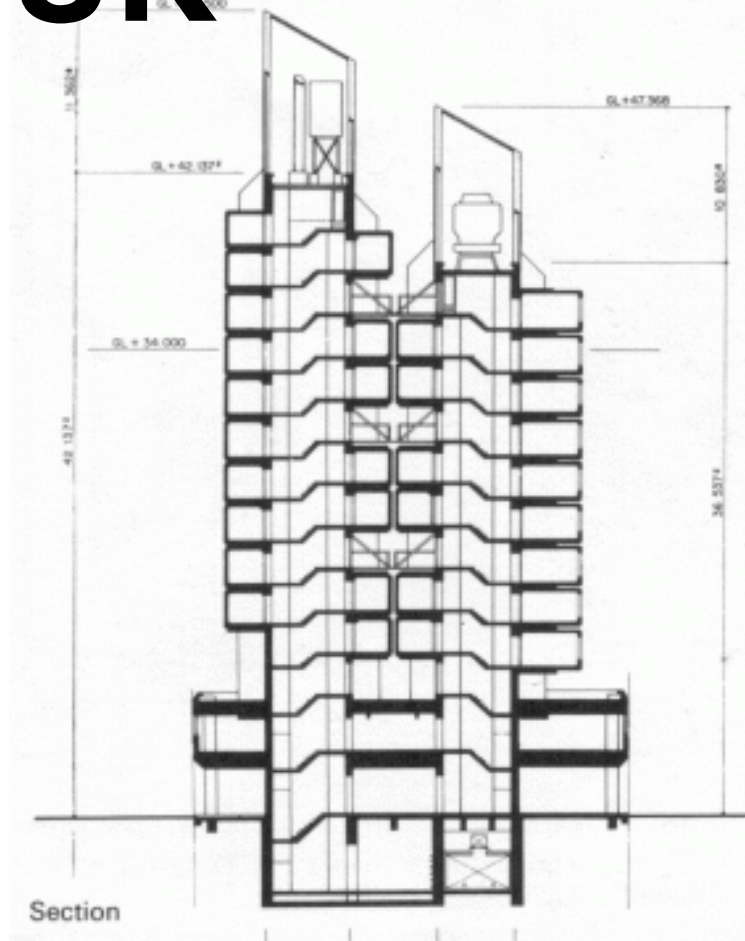

Victoria Hall, one of the first large scale modular buildings of its kind in the United Kingdom, was the world's tallest building built with off-site construction methods in 2009. Designed by O'Donnell East Architects, this high-rise modular apartment tower stands at 251 feet in height.

Victoria Hall, one of the first large-scale modular buildings of its kind in the United Kingdom, was the world's tallest building built with off-site construction methods in 2009. Designed by O'Donnell East Architects, this high-rise modular apartment tower stands at 251 feet in height.

The 25-story building has been mostly constructed off-site. Only the ground floor was site built, with the remaining 24 floors being assembled from 383 individual modules built several hundred miles away in Ireland.

The multiple pressures of speed, quality and scale were the reasons to venture into alternative methods of project delivery.



Site piles were driven and capped, above which the ground floor was built of poured-in-place concrete. The ground floor was designed to act as an architectural plinth as well as a structural transfer beam for the smaller span modular structures above.

Each module has its structural steel frame designed to carry the load of modules above it. The modules also include concrete floors, drywall walls and ceilings, and a fire-rated envelope. All modules are pre-fitted with plumbing, fixtures, finishes, cabinets, and even furnishings before shipping. A rain-screen façade is applied over factory-installed waterproofing.



Meridian First Light House, USA

The idea for the entry comes from the classic Kiwi bach – a New Zealand holiday home - where New Zealanders retreat to 'get away from it all' and get back to basics. Baches exemplify Kiwi values: a strong connection with the landscape, a hands-on 'do it yourself' mentality and socializing outdoors.

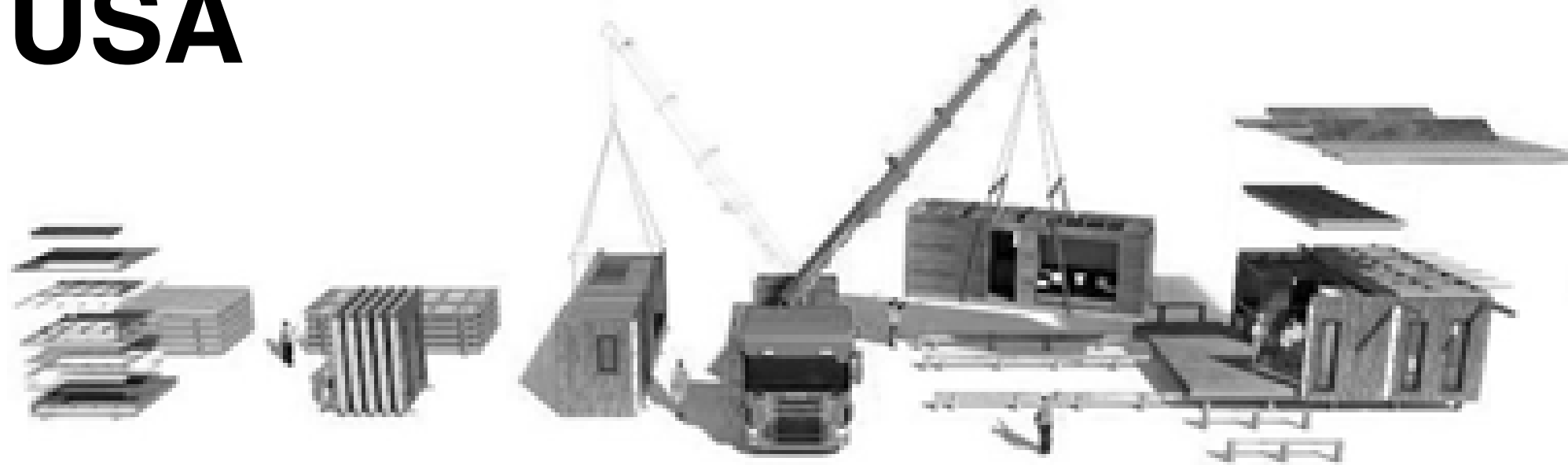
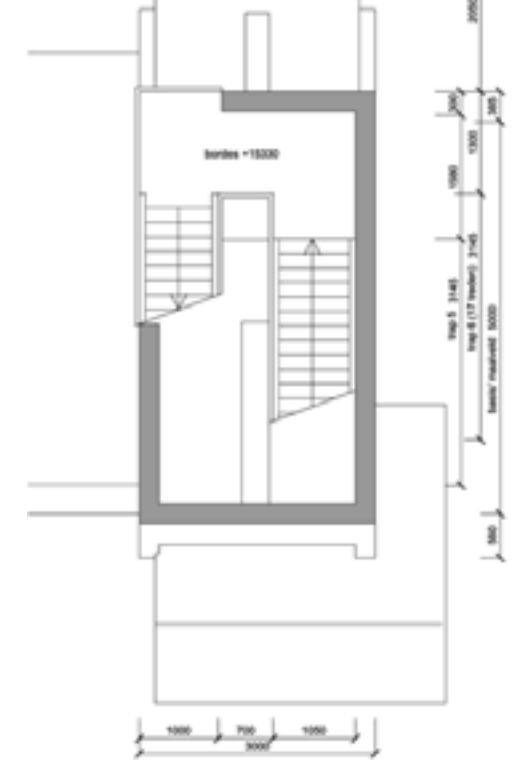

Hybrid structures usually combine panel and modular prefabrication systems to construct a whole building.

Prefabricated and modular, the First Light House has been designed to be easily transported. The house is made up of six independent modules that can be quickly assembled using a crane. This level of prefabrication allowed the team to fit out the modules with finishes, fixtures, plumbing, electrical, and mechanical equipment, which make for a simple and fast connection on-site. Wooden decking surrounds the house, linking the interior to the surrounding environment. The decking is also constructed in modules that are carried into place for quick assembly.

The Victoria University of Wellington team represented New Zealand and was the only entry from the Southern Hemisphere ever to be selected for the U.S. Department of Energy Solar Decathlon 2011, where it ranked 3rd. Led by students from the School of Architecture, the team comprised students from various schools at Victoria University and was supervised by university staff and industry partners who donated their time and expertise to the project.

The First Light House was constructed in early 2011 using Hybrid Construction and opened its doors to the New Zealand public in Wellington during May before being packed up and shipped to the U.S. in July. The idea for the entry comes from the classic

Kiwi bach – a New Zealand holiday home - where New Zealanders retreat to 'get away from it all' and get back to basics. Baches exemplify Kiwi values: a strong connection with the landscape, a hands-on 'do it yourself' mentality and socializing outdoors.

The First Light House is a net-zero energy dwelling; designed to produce at least as much energy as it uses. The house has been designed to maximize energy drawn from the natural climate using a combination of passive and active energy strategies. The result is an efficient and comfort-controlled house that consumes less than a third of the energy of a typical home.



One9, Melbourne

Constructed by Vaughan Constructions using Hickory Group's prefabricated building systems, One9 comprises 34, one and two-bedroom contemporary apartments over nine levels.

Located at 19 Hall Street, just 7 kilometres northwest of Melbourne's CBD in Moonee Ponds, lies a thriving hub of commercial, office and retail activity, bordered by quality residential dwellings and excellent lifestyle amenities. Constructed by Vaughan Constructions using Hickory Group's prefabricated building systems, One9 comprises 34 one-bedroom and two-bedroom contemporary apartments over 9 levels.

The manufactured apartments were erected by Vaughan and Hickory using 36 Unitized Building modules in just 5 days. Vaughan subcontracted Hickory to deliver the 36 modules complete with the facades and fully-fitted with a combination of natural timber floors and high-grade carpets, built-in robes and full-length balconies.

The nature of tall buildings is such that the modules are clustered around a precast concrete core or stabilizing system; the modules are generally designed to resist vertical loads and so horizontal loads are transferred to the concrete core. The Hickory-manufactured apartments offer light-filled and functional spaces for everyday living. Unique, modern designs highlight the capability of the modular technology to adapt to complex architectural concepts, and feature cantilevered terraces on all levels and clean framing on the front façade. One9 was completed in November 2013.

One9 focuses heavily on environmentally sustainable aspects. The environmentally sustainable benefits of the UB System are at the heart of what One9 has to offer, which features a 6-star energy rating. Double glazed windows for superior thermal and acoustic performance, greywater recycling and solar hot water panels on the roof enhance the green aspects of the building. Built with a combination of Aluminium Composite and Designer Panels Diverse Clad System, the facades also incorporate sliding privacy screens for sun protection to the Western Elevation and a floating portal frame to the North Elevation.

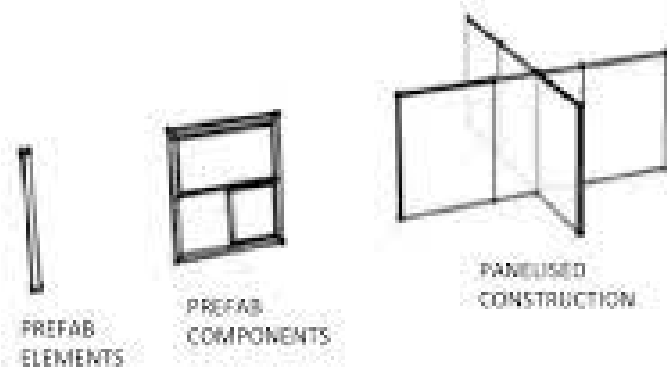

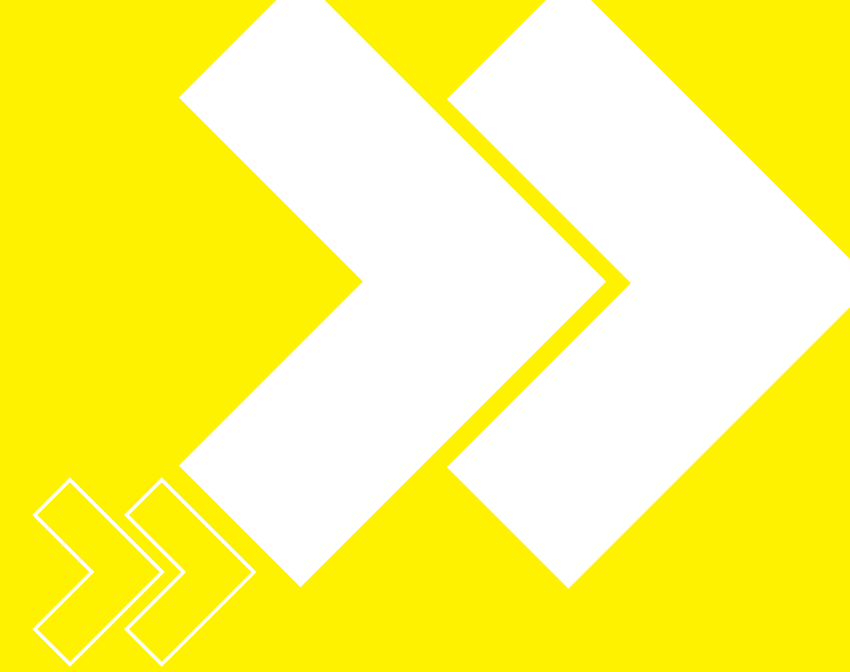

/ CASE STUDIES ON TECHNOLOGY

Prefabricated Sandwich Panel System

Monolithic Concrete Tunnel Formwork

Precast Concrete Construction System

Precast Concrete Construction - 3D Volumetric

Light Gauge Steel System

PVC Stay in Place Formwork

Prefabricated Sandwich Panel System

SIPs are manufactured under factory-controlled conditions off-site and can be installed quickly once on site. The benefits of using SIPs are that they are high-strength, high-performance, and can be fabricated to fit nearly any building design.

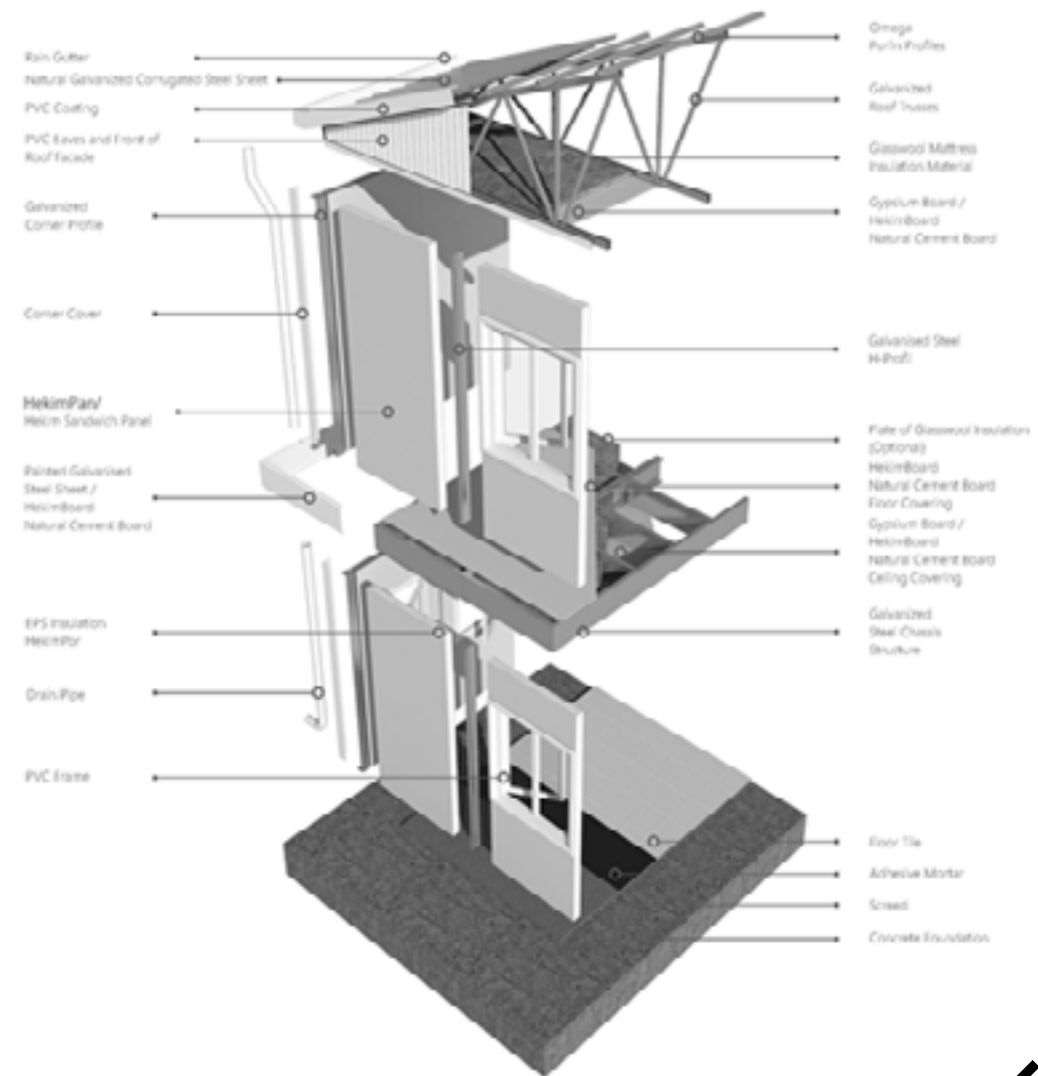

Structural insulated panels (SIPs) are a form of sandwich panel system that incorporates insulation, predominantly used for residential and light commercial construction. They take the form of an insulating foam core sandwiched between two structural facings. SIPs are manufactured under factory-controlled conditions off-site and can be installed quickly once on site. They are high-strength, high-performance, and can be fabricated to fit nearly any building design. The two broad subcategories are:

- The panels made of inner and outer boards (cement/fibre/MGO) with infill core of lightweight concrete/ patented / proprietary materials etc. These panels are both load bearing & non-load bearing categories. When used as infill (non-load bearing walls), Steel / RCC frames may be used.
- The other category is based on reinforced Expanded Polystyrene Core Panel System (EPS).

These reinforced EPS panels as walling, slab, staircase components are finished on site by spraying shotcrete on both sides. EPS Core Panel System is based on factory-made panels, consisting of self-extinguishing expanded polystyrene sheet with a minimum density of 15 Kg/m³, thickness

not less than 60 mm, sandwiched between two engineered sheets of welded wire fabric mesh, made of high strength galvanized wire of 2.5 mm to 3 mm dia.

Expanded Polystyrene (EPS) Core Panel System is based on factory-made panels, consisting of self-extinguishing expanded polystyrene sheet with a minimum density of 15 Kg/m³, thickness not less than 60 mm, sandwiched between two engineered sheet of welded wire fabric mesh, made of high strength galvanized wire of 2.5 mm to 3 mm dia.

Know More:
<https://bit.ly/3h2sM1M>

Monolithic Concrete Tunnel Formwork

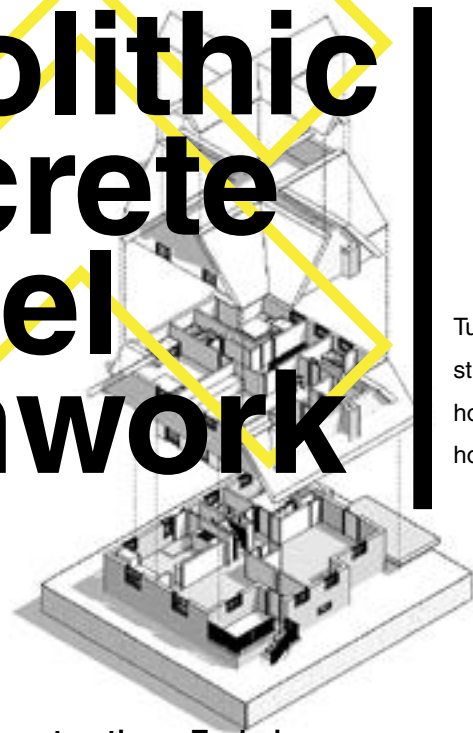

Tunnel form is widely used in the construction of cellular structures with a high degree of repetition such as private housings, hostels, student accommodation (hostels), prisons, hotels and commercial developments

The **Tunnel Form Construction Technique** produces high-quality monolithic structures. It eliminates the use of any subsequent wet trades (plastering etc.). It is the process to cast walls and slabs in one operation in a daily cycle. This technique is highly systematic, earthquake proven and provides an ideal solution to the critical problem of sound transmission. It ensures sound reduction of 50 decibels. Tunnel form is widely used in the construction of cellular structures with a high degree of repetition such as private housings, hostels, student accommodation (hostels), prisons, hotels and commercial developments

It reduces the heating costs by providing 'Thermal Mass' and speeds up the building process. However, specialist contractors with tunnel-form experience are highly recommended to tailor the design to suit the best construction method. Tunnel formwork comes in half units and in the form of an inverted "L" which are bolted together at the top to form each tunnel. The inbuilt wheels and the jacks help the formwork move in and out of position and

adjust to the final height.

The factory-made steel formwork can be reused up to 600 times and it can suit a variety of module sizes. This makes the method of construction versatile and economical. Tunnel-formwork allows a 24-hour construction cycle to be achieved and thus the buildability of in-situ concrete is improved by choosing this type of formwork. In practice, when the two halves are bolted together.

The on-site implementation of a 24-hour cycle is divided into the following operations.

1. Stripping of the formwork from the previous day.
2. Positioning of the formwork for the current day's phase, with the installation of mechanical, electrical and plumbing services.
3. Installation of reinforcement in the walls and slabs.
4. Concreting the heating equipment if necessary.



The Casting Process of Tunnel Formwork:

Stage 1: Prefabricated Wall reinforcement is placed by a crane along the entire wing before casting the kickers (used to position wall formwork).

Stage 2: The two and a half tunnel is craned into place, bolted together and ties are added.

Stage 3: The wall concrete is poured.

Stage 4: The slab reinforcements are fixed

Stage 5: The slab concrete is placed. The formwork system provides for a pour to be wrapped in tarpaulins and for the use of butane heaters to maintain a sufficiently high temperature for the concrete to reach its striking strength overnight.

Know More:
<https://tinyurl.com/j8rvu43y>



Stage 6: The tunnel forms are removed the next day.

Stage 7: The process is repeated for the next two bays. Tunnel form can produce strong and durable in-situ cellular structures. This method of construction can achieve time savings up to 25% with cost savings of 15%. Since the concrete finish is very good, the requirement for post-construction trades such as plasterers and electricians are greatly reduced.

Precast Concrete Construction Components

Precast Concrete is a form of concrete that is prepared, cast and cured off-site, usually in a controlled factory environment, using reusable moulds. Precast concrete elements can be joined to other elements to form a complete structure. It is typically used for structural components such as wall panels, beams, columns, floors, staircases, pipes, tunnels, and so on.

Installation

The on-site installation of precast components can be a high-risk activity involving the use of heavy plant, cranes and personnel working at height. Consideration should be given therefore to safeguarding against risks when receiving delivery, moving, and placing units.

Consideration should be given to:

- The method and sequence of assembly and erection.
- The method of providing temporary supports.
- Structural connections and joint details.
- Tolerances.
- Handling and rigging requirements.
- Site accessibility for delivery and storage.
- Crane capacity and working clearance for hoisting.
- Sample measurement to confirm the accuracy of critical dimensions.

- Visual inspection of concrete finishes for defects.
- Locations and conditions of lifting inserts for hoisting.

Site versus factory pre-casting

Precasting can be carried out at a casting yard, in or near the site, or in a factory. A key aspect of determining whether to use site or factory precasting is transport costs. Factory work offers superior quality for obvious reasons, so if there is a factory close to the site, it makes sense to use it.

If a precasting yard is to be created, space must be laid out for the following activities:

- Storing the raw materials, such as cement, aggregate, sand, admixtures, water, reinforcement bars, and steel or plywood sheets for formwork. A formwork making and maintenance yard.
- A concrete mixing plant.
- A steel reinforcement yard to make rebar cages to be placed inside the concrete.
- A casting area.
- A curing area.
- A stacking area for finished components.

Connecting precast concrete elements

Precasting can be carried out at a casting yard, in or near the site, or in a factory. A key aspect of determining whether to use site or factory precasting is transport costs. Factory work offers superior quality for obvious reasons, so if there is a factory close to the site, it makes sense to use it.



Precast concrete components can be connected in several ways:

- They can be bolted together. To do this, steel connectors are embedded in the concrete at the time of casting. This must be done with great precision. A concrete mixing plant.
- They can be grouted or concreted together. In this method, loops of steel reinforcement are left protruding out of the precast concrete members. Two members are placed in position, and

reinforcement is threaded between the loops. Fresh concrete is then poured around this reinforcement, in a space left for this purpose.

Know More:
<https://bit.ly/2UeyaWs>



Precast Concrete Construction - 3D Volumetric

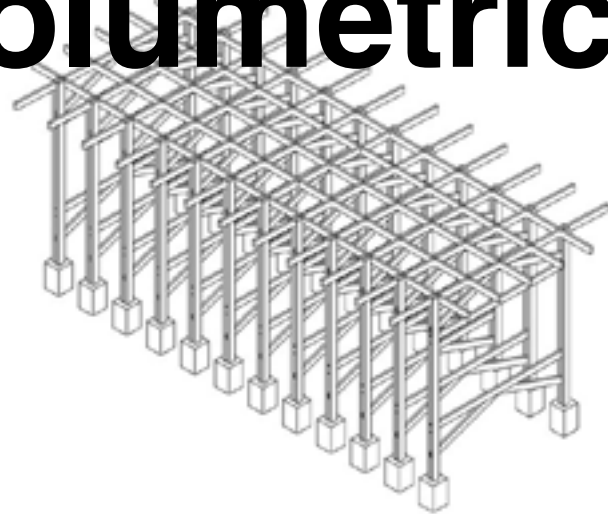

This advanced technique involves the production of three-dimensional fabricated modules in controlled factory conditions before the actual transportation to the site.

3D Modular Construction is a revolutionary method of building construction, which allows large-sized modules to be constructed comprehensively in a factory. It saves time and significantly reduces the cost.

This advanced technique involves the production of three-dimensional fabricated modules in controlled factory conditions before the actual transportation to the site. The modules can be brought to the site either as a basic structure or with all the finishes (both external and internal).

The manufacturing process for the modules is as follows:

- 3D steel moulds are created as suiting to various sizes of building Units

- High strength steel as per the structural design is placed inside 3D moulds
- Electrical and plumbing lines are set up. Block outs for doors and windows are also set up at the same time.
- The pods are cast into their final shape using high-performance concrete.
- Stringent quality check is taken for each step.

This novel method of construction offers core benefits of concrete-like thermal mass, fire and sound resistance, accuracy, durability and faster erection at the project site. This technology provides ease of implementation as most of the activities take place off-site, with minimum work at the building site.



3D volumetric precast process

Unlike the 2D methodology, this technology involves modules fitted with windows, doors, and electrical and plumbing conduits.

All five sides are cast in a single pour creating a single room or multiple rooms in one go. The three-dimensional design process allows for customizing moulds at the design stage. All the openings like doors, windows, and conduits are designed into the mound. The openings are so precise that they can be ordered right from the drawings. Incorporating all the features at the design stage reduces cost and project turnaround time.

Sequential construction in the project begins with keeping

Know More:
<https://bit.ly/2UeyaWs>



the designed foundation of the building ready, while the manufacturing of precast concrete structural modules take place at the factory. Factory-finished building units/modules are then installed at the site with the help of tower cranes. Gable end walls are positioned to terminate the sides of the building. Prestressed slabs are next installed as flooring elements. Rebar mesh is finally placed for structural screed, thereby connecting all the elements. Consecutive floors are built similarly to complete the structure.

Light Gauge Steel System

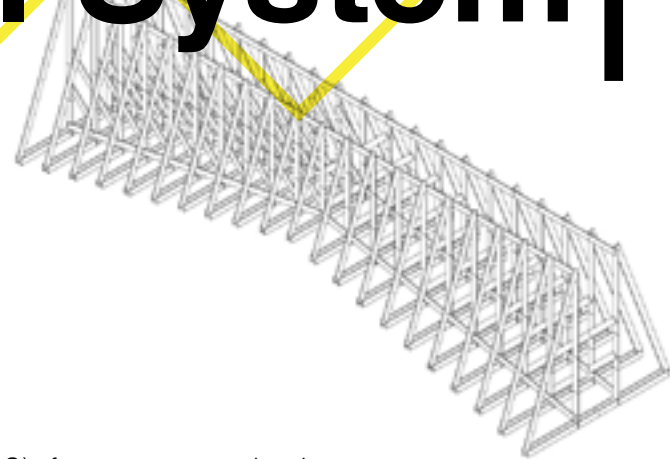

Tunnel form is widely used in the construction of cellular structures with a high degree of repetition such as private housings, hostels, student accommodation (hostels), prisons, hotels and commercial developments

Light Gauge Steel (LGS) frame construction is an innovative and reliable construction method that is broadly used in the world and has surpassed wood frame construction in many design and construction aspects.

It offers several advantages such as buildability, strength, design flexibility, sustainability, and lightness in weight, which make it easy to handle and hence increase speed, safety, and quality of construction. Nonetheless, it is easily influenced by fire, and so fire protection coating has to be provided.

The LGS frames are manufactured in a factory and assembled into LGSF wall structures and then transported to the construction site and erected wall by wall on a pre-built concrete floor as per the floor plan of the building. Steel reinforced concrete panels of size 800mm X300mm X20mm thick are manufactured at the factory and transported to the site. These panels are fixed on either side of the LGSFS wall using self-drilling/tapping screws

to act as outer and inner faces of the wall leaving a gap between them. This gap is then filled with lightweight concrete using a special mixing and pumping machine. Electrical and plumbing pipes/conduits are provided in the service holes of the LGSFS before concreting is done. Self-compacting concrete is mixed and pumped into the gaps between two panels. The concrete flows and fills the gap and provides adequate cover to the LGS frames and joints. The concrete shall also adhere to the concrete panels. After curing, LGSFS with in-fill concrete and panels (LGSFS-ICP) forms a monolithic sandwich composite wall structure with thermal and sound insulation properties.

Components of Light Gauge Steel Frame:

1) Wall System

A load-bearing wall carries vertical loads from the construction above or lateral loads resulting from the wind. These loads may act separately or in combination. Both internal and external walls may be load bearing. Other types of walls include non-



Know More:
<https://bit.ly/2UeyaWs>



C-shaped members are punched at the factory to provide holes at 600 mm intervals. These are designed to permit wiring, piping, and bracing to pass through studs and joists without the need for drilling holes on the construction site. Channel Shapes are used for top and bottom wall plates and joist headers.

6) Accessories

A variety of sheet metal angles, straps, plates, channels, and miscellaneous shapes are manufactured as accessories for light gauge steel construction.

7) Connections

Light gauge steel members are usually joined with self-drilling, self-tapping screws, which drill their holes and form helical threads in the holes as they are driven.

Welding is often employed to assemble panels of light gauge steel framing that are prefabricated in a factory, and it is sometimes used on the building site where particularly strong connections are needed. After completion of the ground floor, the first, second and third floors of the building is constructed using the same procedure that of the ground floor. The staircase, chajja and parapet walls of the building are also constructed using LGSFS-ICP Technology.

load bearing walls, wall cladding, and partitions.

2) Flooring System

The flooring system can be made up of C-sections as joists connected to C section bearers. The floor joists can be designed from a range of C-section sizes depending on loading parameters.

3) Roof System

The roof structure is generally a steel truss system that can be designed for metal sheets or tiles. The steel roof framing system can suit all types of roof design – hip, gable, Dutch gable, steel roof sheeting or tile – and would be screwed directly onto the wall frame.

4) Light Gauge Steel Coating

The thickness of coating applied on the surface of light gauge steel varies, based on environmental conditions in which the steel members are placed. Commonly, marine environments need the most protection, whereas dry regions require fewer protections.

5) Shapes of Light Gauge Steel Frame Members

C shapes are considered for studs, joists, and rafters. The webs of

PVC Stay in Place Formwork

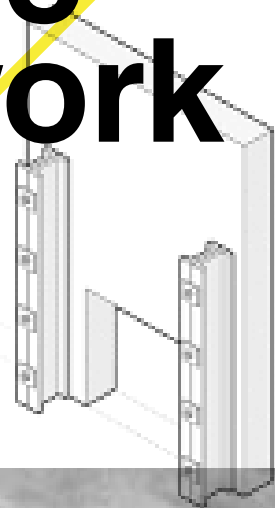

It was found that the PVC encasement enhanced the thermal insulation property, one of the fire resistance performance criteria.

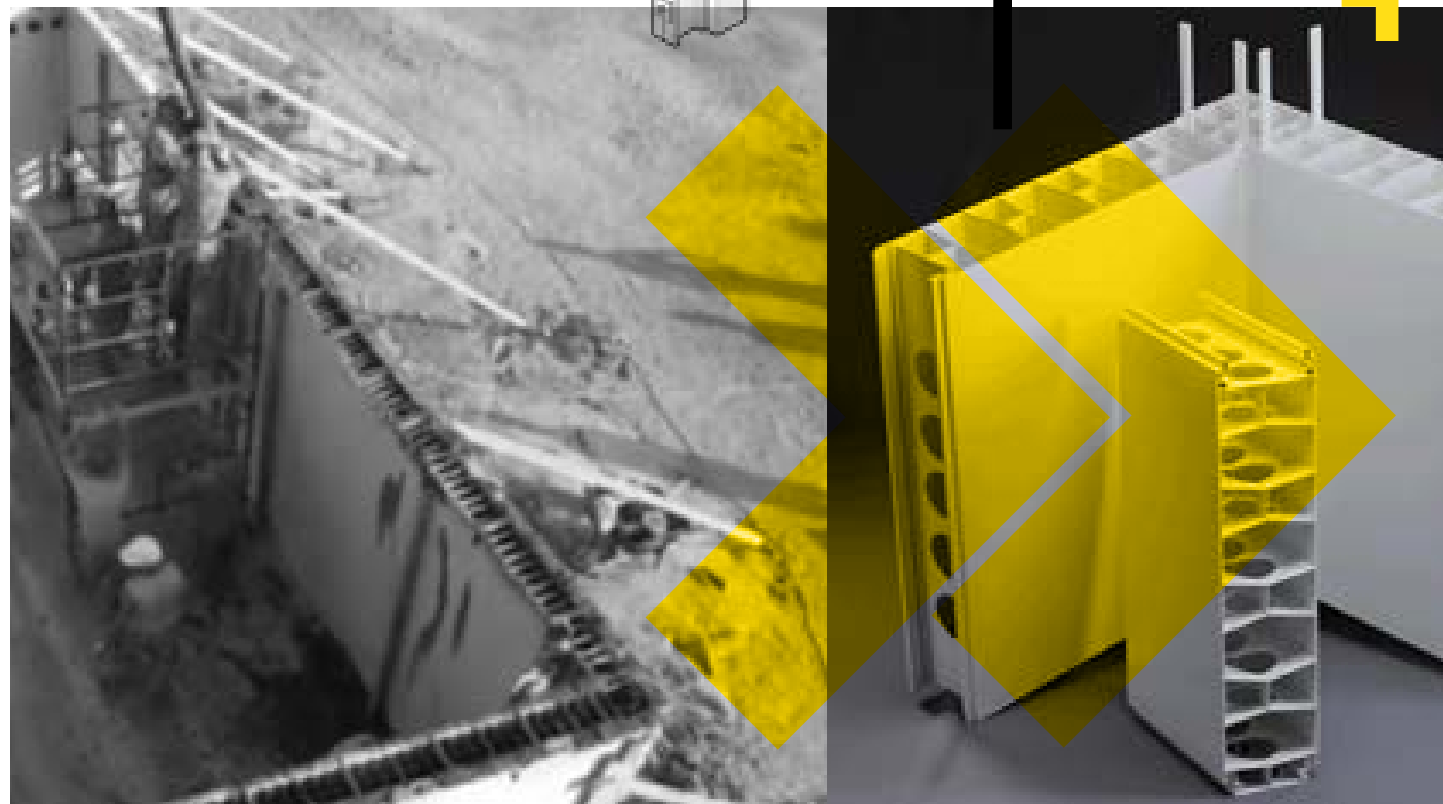

Stay-in-Place (SIP) formwork is a more practical alternative to traditional steel or wood formworks due to its improved constructability and durability.

PVC Wall Forms have been developed in various cross-sectional sizes as per project requirement. The common sizes are 64mm, 126mm, 166mm & 206mm. However, Novel System types N64 and N126 are also available.

- N64 walls are erected individually and not preassembled, except for headers and sills.
- Pre-assembled wall sections are used for walls over 4300 mm (14') high
- The height of walls made with the formwork varies according to the requirement.
- N126 walls less than 4300 mm (14') high are erected individually except for walls of unique projects and headers and sills.

It was found that the PVC encasement enhanced the thermal insulation property, one of the fire resistance performance criteria. Overall, the importance of this alternative formwork is the reduction in the use of forest resources, the raise of awareness of their conservation, and the promotion of their rational use as this material is friendly to the environment.

The Process:

- Prefabricated SIP Wall panels and Hot Rolled Sections are transported to the site. PEB HR Sections are erected on a ready foundation prepared in a conventional manner using cranes and required screws and connections.
- Floor slab is erected using a decking sheet. Once the structural frame and floor are installed and aligned; SIP Wall panels fixing start with a box connector at a corner or a T-intersection and the two adjacent panels as per the design on the decking floor. Temporary bracing and

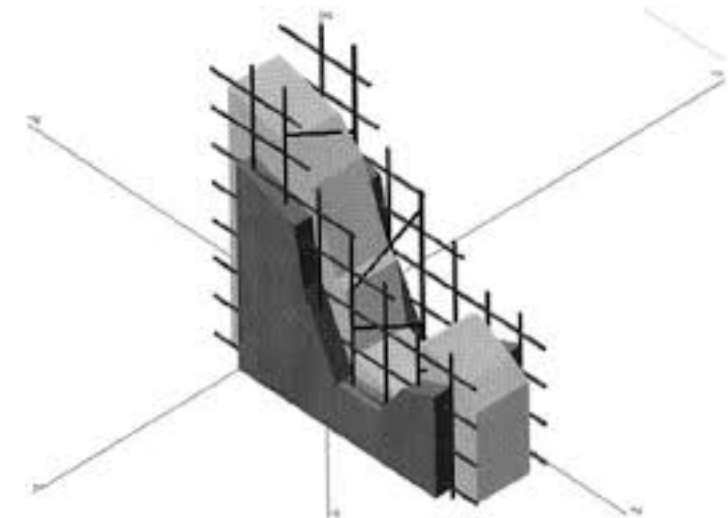

steel reinforcing bars shall be installed as the wall erection proceeds. SIP Wall panels with provisions of holes for services conduits are reinforced with a minimum amount of reinforcement.

- The extruded components slide and interlock together to create continuous formwork with the two faces of the wall connected by continuous web members forming hollow rectangular components. The web members are punched with cores to allow easy flow of the poured concrete between the components.
- Cavities inside the wall panels are filled with concrete which imparts the required hardness to SIP Wall panels.
- Upon installation of SIP wall panels, flooring and Ceiling Finishing work is executed.
- Other services accessories, instrument and equipment are installed at the final stage.

Know More:
<https://bit.ly/3ht7d9u>



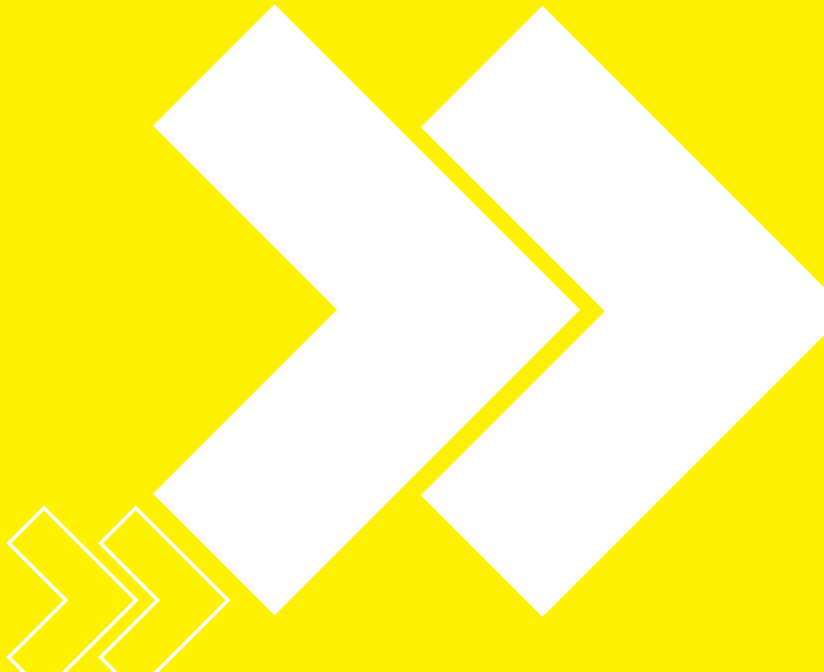

/ CASE STUDIES ON PROCESSES AND SOFTWARE

// PROCESSES

VOLUMETRIC CONSTRUCTION

HYBRID CONSTRUCTION

PANELIZED CONSTRUCTION

SUB-ASSEMBLIES AND ACCESSORIES SYSTEMS

TILTING MOULDS

// SOFTWARE

TEKLA

DREAMPLAN

//PROCESSES

Volumetric Construction



In **Volumetric Construction**, three-dimensional units are produced in the factory and are then brought to the site and bolted together. The frames constructed can be either steel, timber or concrete. The factory possesses quality-controlled systems for production as a part of third-party approval.

Volumetric construction is also called modular construction. The modules can either be bought in different forms like the basic structural shell or the one whose internal and external finishes and services.

This construction may consist of either a frame made of a single material or composite materials. Volumetric construction is divided into two components:

- Modular Construction
- Pod Construction

a. Modular Construction

In this type, factory-produced pre-engineered building components are delivered to the construction site. These modules are then assembled on site as large volumetric components or as substantial elements.

b. Pod Construction

Pods are non-structural elements that are used with a load-bearing structure. They are mainly employed

Volumetric construction is also called modular construction. The modules can either be bought in different forms like the basic structural shell or the one whose internal and external finishes and services.

for the construction of replicable units for hotels and accommodation spaces.

In this type of construction, three-dimensional elements are employed in the superstructure of the building. These form ready-made rooms, which can be combined to obtain a complete premise. These are set together within a light steel framework. All the final building services are pre-installed at the site that just involves the final connection.

Unlike the 2D methodology, this technology involves modules fitted with windows, doors, and electrical and plumbing conduits. All five sides are cast in a single pour creating a single room or multiple rooms in one go. The three-dimensional design process allows for customising moulds at the design stage. All the openings like doors, windows, and conduits are designed into the mould. The openings are so precise that they can be ordered right from the drawings. Incorporating all the features at the design stage reduces cost and project turnaround time.

After precast components, the next stage of evolution of construction should be manufacturing the houses, not just as a combination of 2D elements but as modules that deliver a room or more from each precast as 3-Dimensional Monolithic Modular Volumetric Precast.



//PROCESSES

Hybrid Construction

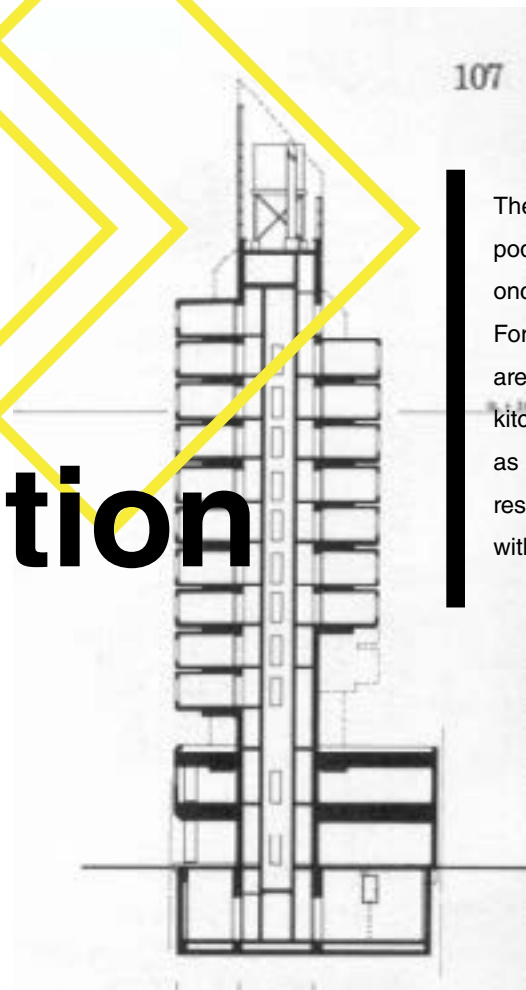

The hybrid systems also called pods are transported to the site, once their finishing is complete. For example, highly serviced areas like bathrooms and kitchens are initially constructed as volumetric units where the rest of the dwelling is constructed with the help of panels.

Hybrid Construction combines both volumetric and panelized approaches to develop a single building. Hence this construction is also called semi-volumetric. The hybrid systems are either building facilities that are fully manufactured or prefabricated in the factory. These units with the complete final finish.

The hybrid systems, also called pods, are transported to the site, once their finishing is complete. For example, highly serviced areas like bathrooms and kitchens are initially constructed as volumetric units while the rest of the dwelling is constructed with the help of panels.

Different materials are used according to their strengths and weaknesses to provide simple,

buildable and competitive high-quality structures that offer consistent performance. Hybrid concrete construction can incorporate all the benefits of pre-casting, (e.g., form, finish, colour, speed, accuracy, prestressing, high-quality, assured covers and dense and properly cured concrete) with all the benefits of in-situ construction (e.g., economy, flexibility, malleability, continuity and robustness).

Structural Action of Hybrid Concrete Construction

1. Independent Action

Precast cladding adorns mainly in-situ framed buildings. Simple repetitive portions of a structure may naturally lend themselves to precast construction whereas more complicated, less



accessible sections may lend themselves to in-situ construction.

2. Combined Action

Precast units can directly replace in-situ elements, for example, stair flights or hollow-core floor units within in-situ frames. Units can be used as permanent formwork, substituting for and largely obviating the need for conventional formwork. This brings the advantages of factory-engineered concrete to the site.

3. Composite Action

In-situ concrete toppings are often added to precast floors for additional strength, stiffness and

robustness. In-situ floor slabs can be cast on top of precast downstand beams to give highly efficient composite T beams.

Advantages of Hybrid Construction

1. Saving of construction time and money.
2. Increased buildability of design.
3. Enhanced safety of workforce.

Know More:
<https://bit.ly/2UeyaWs>



//PROCESSES

Panelized Construction

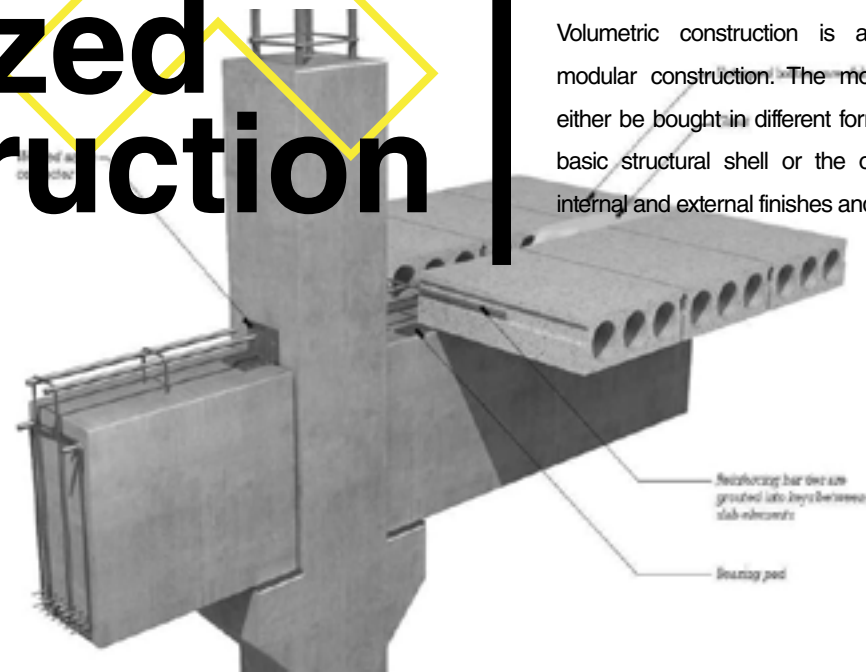

Volumetric construction is also called modular construction. The modules can either be bought in different forms like the basic structural shell or the one whose internal and external finishes and services.

These are flat panel units used in the form of walls, floors or roof panes to create a complete structural shell. These panel units are built in the factory and transported to the site for assembling as a three-dimensional structure or to fit into an already on-site constructed structure.

The structural floors and roofs that are factory-made are also called cassettes. These cassettes can be either a load-bearing structure or non-load bearing structure.

These structural panel units can be made out of timber, insulated panels or light gauge steel or concrete or non-structural in-fill walls. Any type of building can make use of such panel units. Some of the examples of building components constructed using panelized systems are windows, timber frames and insulation.

The panelized construction can either make use of open panels, closed panels, concrete panels,

insulated panels, composite panels and infill panels.

Panelization is also an environmentally friendly way to build. Instead of filling up Dumpsters with debris on site, cut-offs of wood and other materials can be recycled and used for other projects in the factory. Drywall and wiring that is not being used can be returned to the manufacturer and recycled.

Transporting materials is simpler and less expensive, for example, than modular construction, which may require several flatbed trucks to deliver the modules. On the downside, modular houses are inspected in the factory, eliminating that requirement. With panelized houses, they are inspected on-site, the same way as frame construction would be. With panelized construction, as with other prefabricated types of construction, it is easier to stay on budget because more of the design must be completed before construction will begin.

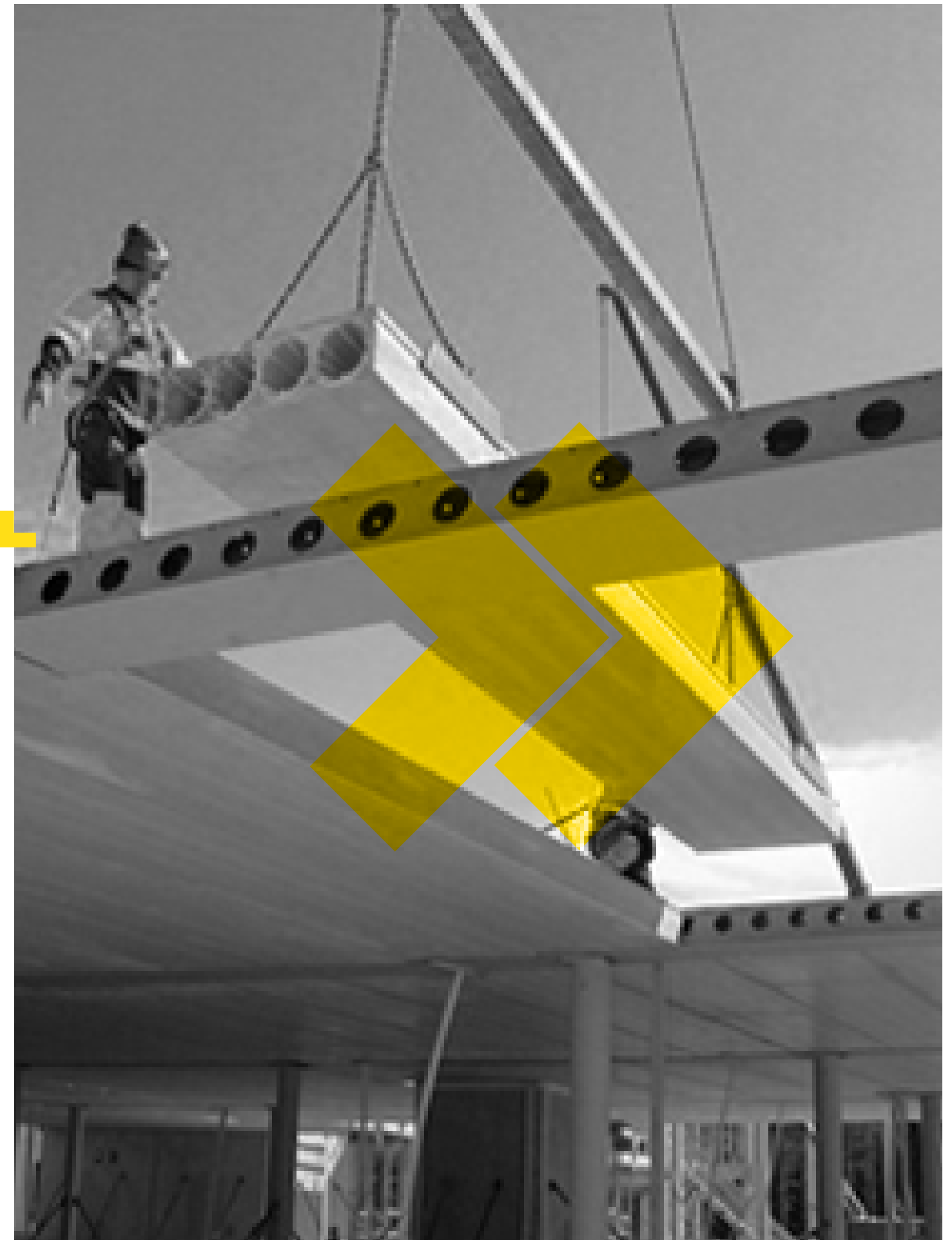

//PROCESSES

Sub-Assemblies and Accessories System



This construction type involves the manufacture of small building components like roof trusses, floors piping, staircases, roof trusses, precast concrete beams and columns. The sub-assembly system can also consist of prefabricated foundations, floor cassettes (i.e., prefabricated floor panels) and roof cassettes (i.e., prefabricated roof panels).

The **Sub-Assembly** system is the process by which the building components are initially constructed at the offsite location before they are permanently erected at the site. These elements include the building components, materials, equipment and prefabricated parts.

A series of different pre-manufacturing approaches, which include unitised non-structural walling systems, roofing finish cassettes or assemblies (not part of a wider structural building system), non-load bearing mini-volumetric units (also called 'pods') and used for the highly serviced and more repeatable areas such as kitchens and bathrooms, utility cupboards, risers, plant rooms as well as pre-formed wiring looms (i.e. pre-assembled cabling systems), mechanical engineering composites would fall into this category.

This construction type involves the manufacture of small building components like roof trusses, floors piping, staircases, precast concrete beams and columns. The sub-assembly system can also consist of prefabricated foundations, floor cassettes (i.e., prefabricated floor panels) and roof cassettes (i.e., prefabricated roof panels).

Any part of a building made in a factory and brought to the construction site can be classed as a sub-assembly, which forms part of a component system. Sub-assemblies can be as small as locks and handles for the doors, or they can be larger components such as pre-assembled roof trusses. Sub-assemblies are likely to



be used in a construction project that predominantly uses onsite techniques, but enables some of the trickier components to be built in a factory that allows for more precision than the building site.

Sub-assemblies and components may be added to existing brick and mortar buildings as well or even to those built using other modern methods of construction.



//PROCESSES

Tilting Moulds Tables

Tilting tables can incorporate one or more sides depending on the kind of panels to be cast.

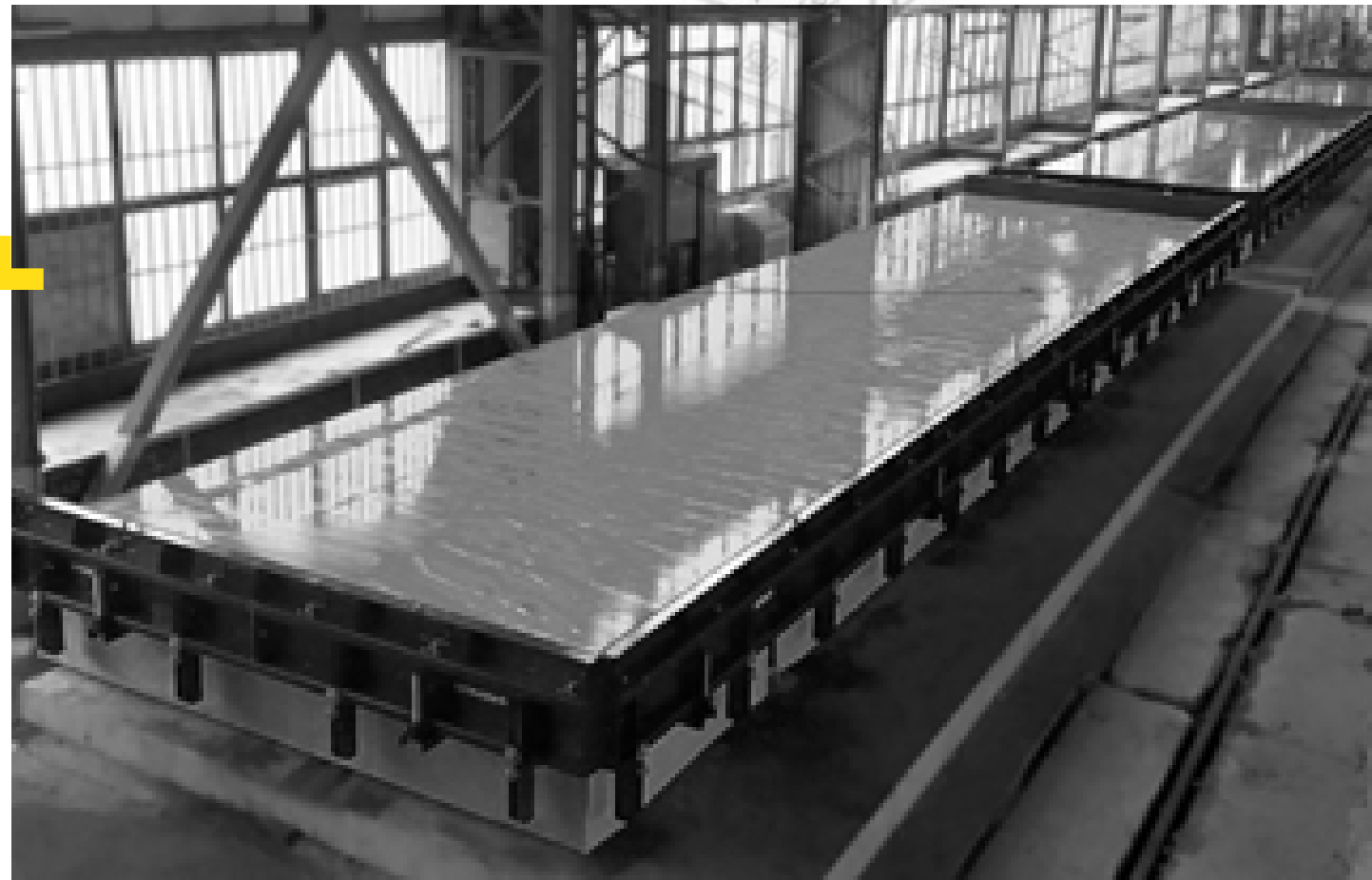

Tilting Tables are designed to produce prefabricated concrete panels in various thicknesses for residential, commercial and industrial buildings. Its tilting mechanism allows removing the panels vertically, with ease and with less time, for concrete hardening.

This tilting mechanism consists of a set of telescopic hydraulic cylinders and its number and strength are in accordance with the size and load capacity of the table. The cylinders are activated by a hydraulic unit with an electrical control panel that can either command one or more tables, depending on the project.

Tilting tables can incorporate one or more sides depending on the kind of panels to be cast. The sides of the tilting tables may be fixed, collapsible or adjustable in height. In addition, the movement of the collapsible and the adjustable sides can be performed mechanically or hydraulically.

Panels for industrial buildings tend to be cast with

standard size and, therefore, a table with a fixed and a collapsible side is usually used. However, panels for a residential project may vary greatly in size and shape and therefore require a more flexible solution.

The sides incorporated into the tilting tables are usually complemented by flexible shuttering systems using magnets. These shuttering systems are also used to form the panels' window and door openings. A variety of shuttering systems are available for the best solution for each project.

Tilting tables can incorporate a vibration system consisting of a series of vibrators that can be electric or pneumatic. Another option to increase the production of the tilting tables is the finned pipe system with isolation canvas for heating. This system leads hot water or steam to accelerate the concrete hardening. To guarantee a smooth and shiny finish of the panel surface, they can give the casting surface of the tilting table an optimum polish creating a 'mirror-like' effect.

//SOFTWARE

Tekla

Tekla Tedds is an application for automating repetitive structural and civil calculations. The software is used in engineering for creating output such as calculations, sketches and notes.

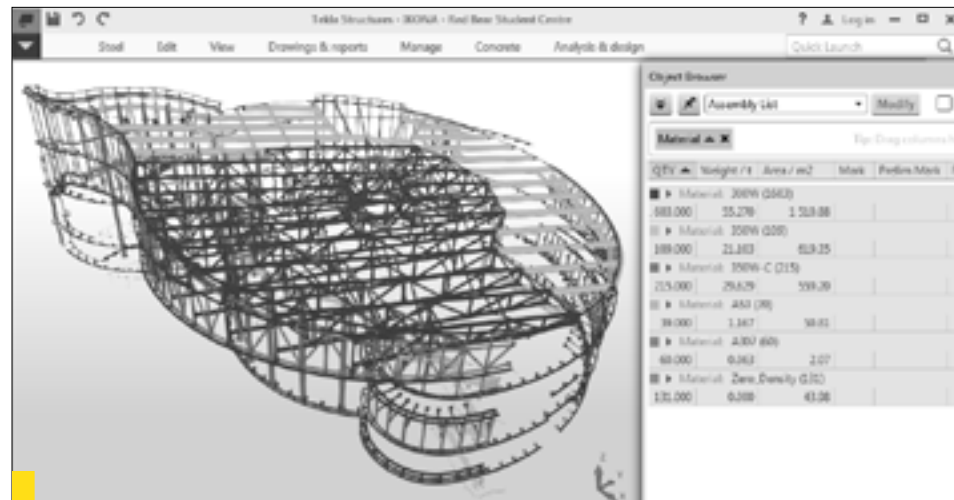

Tekla is a software product family that consists of programs for analysis and design, detailing and project communication. Tekla software is produced by Trimble, the publicly listed US-based technology company.

Tekla Structures is 3D building information modelling (BIM) software used in the building and construction industries for steel and concrete detailing, precast and cast-in-situ. The software enables users to create and manage 3D structural models in concrete or steel and guides them through the process from concept to fabrication. The process of shop drawing creation is automated. Along with the creation of CNC files, files for controlling reinforcement bending machines, controlling precast concrete manufacturing, and importing in PLM-systems can also be built. Tekla Structures are available in different configurations and localized environments to suit different segment- and culture-specific needs.

Tekla Structural Designer is software for the analysis and design of

concrete and steel buildings.

Tekla Tedds is an application for automating repetitive structural and civil calculations. The software is used in engineering for creating output such as calculations, sketches and notes.

Tekla BIMsight is a software application for building information model-based construction project collaboration. It can import models from other BIM applications using the Industry Foundation Classes (IFC) format, also DWG and DGN. With Tekla BIMsight, users can perform spatial coordination (clash or conflict checking) to avoid design and constructability issues and communicate with others in their construction project by sharing models and notes.

Know More:
<https://bit.ly/3AjqPB>

//SOFTWARE

Dream Plan

Tekla Tedds is an application for automating repetitive structural and civil calculations. The software is used in engineering for creating output such as calculations, sketches and notes.



DreamPlan Home Design Software makes designing a house convenient and easy. It is possible to work with pre-made samples, trace a blueprint, or start on a blank plot of land. One can also build a project with multiple stories, decks and gardens, and a customized roof. It is suitable for redesigning various areas of the home like bedroom, kitchen, bathroom, backyard, and more.

Parabuild is a complete detailing package for drawing parametric 3D models of steel structures. Parabuild uses the 3D model to automatically generate documentation such as Workshop drawings, Bills of materials, and CNC files. The unmatched approach to user input makes it very easy to learn and use. Features of Parabuild include an easy and intuitive user interface, and it is easy to learn, time-saving and expandable without programming.

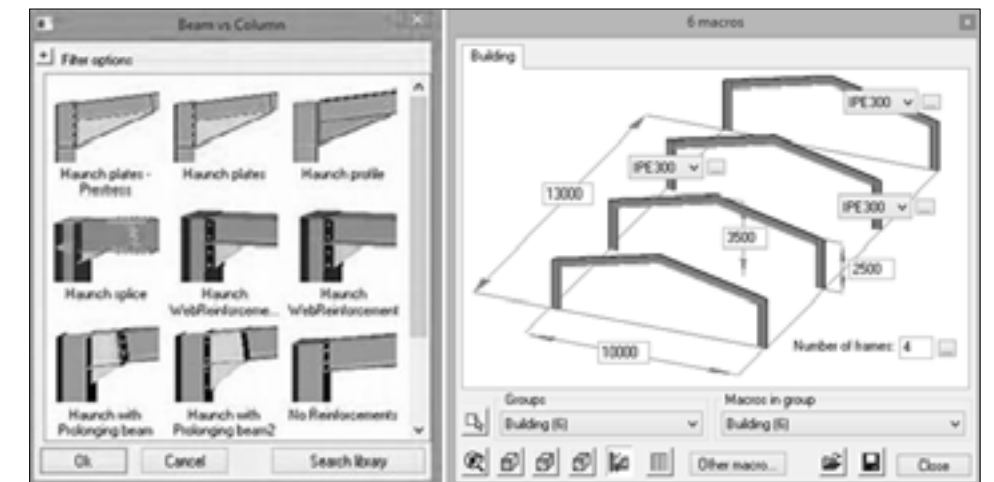

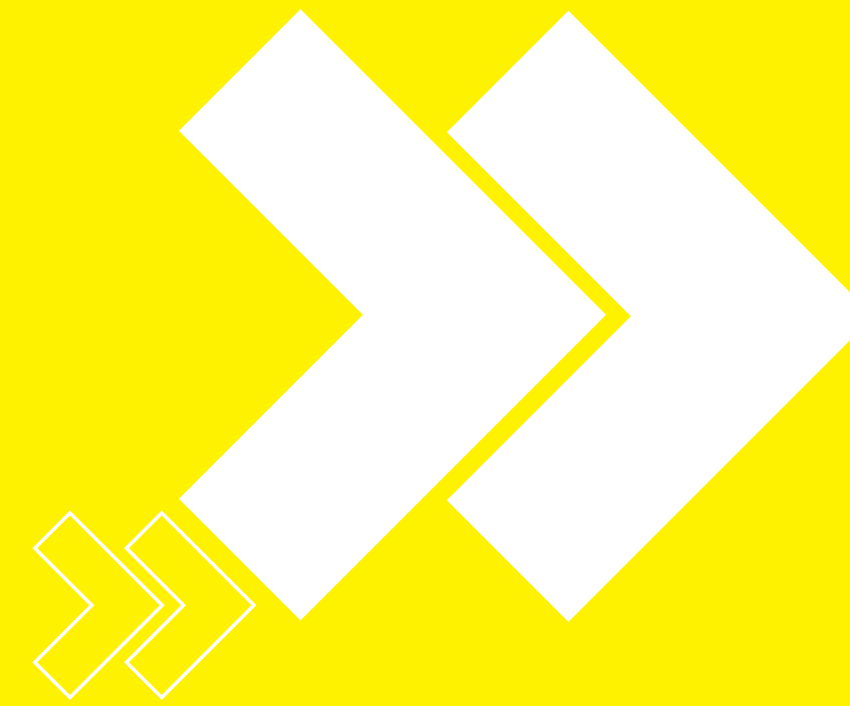

/ CASE STUDIES ON MATERIALS

STRUCTURAL INSULATED PANELS

RAPID HARDENING CEMENT

QUICK SETTING CEMENT

Structural Insulated Panels

The core of SIP is usually non-structural and ridged.



Structural Insulated Panels (SIP) are sandwich panels which are utilised as structural members such as a wall, roof, and floor for concrete structures. These panels vary in different thicknesses of two layers of rigid material as the skin and a thicker layer as the core. It can be made of various materials based on its application.

The core of an SIP is usually non-structural and ridged. It is commonly made of plastic foam such as Extruded Polystyrene and Expanded Polystyrene (EPS) as well as Polyurethanes (PUR) foam such as polyisocyanurate and polyisocyanate. PUR foam has better performance against fire, flaming, and smoke rating. The SIPs which are made of PUR foam are stronger than those made of EPS

against axial, flexural, and lateral loads. Injected PUR foam can easily adhere to all SIP components such as skin material, cam lock, top plates, and electrical boxes. Thus, it allows a durable bond between the mating surface and the foam.

There is a variety of SIP skin materials suggested by researchers based on their advantages and SIP application such as metal, fibre cement, cement, calcium silicate, gypsum, and oriented strand board. The SIP skin must be fire-treated to comply with local and national building codes. As an example, according to the International Code Council (ICC), a 15-minute thermal barrier from the interior of a building must be obtained by foam plastic insulation (IBC section 2603.4). Among the common SIP skins,



OSB is cheaper than the other skin material.

However, the drawbacks of OSB confine its application as a SIP face sheet. SIP made of OSB can be utilised as a partition wall that is not exposed to moisture. However, it has decorative applications such as partition wall in shops.

Aluminium and steel transfer the heat from out of SIP to the core quickly. The rate of heat transferring is very high for these materials. Thus, it confines its SIP application. The potential flammability of Fibre Reinforced Polymer (FRP) causes a serious problem for its application as SIP face sheet because even using sheetrock does not meet the fire code requirements. Among these types of skins thereof, a cement board is more convenient to use as SIP skin.

Nevertheless, there is a need for future research to improve its brittle failure. The connection of SIP panels should be improved using new material and design to enhance its stability.

Know More:
<https://bit.ly/3xdjTbn>

Rapid Hardening Cement

The strength of rapid hardening cement at the three days is similar to 7 days strength of OPC with the same water-cement ratio.

Rapid Hardening Cement (RHC) attains high strength in the early days and is used in concrete where formworks are removed at an early stage and are similar to Ordinary Portland Cement (OPC). This cement has increased lime content and contains higher c3s content and finer grinding, which gives higher strength development than OPC at an early stage.

The strength of rapid hardening cement at three days is similar to 7 days strength of OPC with the same water-cement ratio. Thus, the advantage of this cement is that formwork can be removed earlier, which increases the rate of construction and decreases the cost of construction by saving formwork cost.

The manufacture of rapid hardening cement is done by the dry process of cement manufacture. In this cement, limestone and shale are used as raw material and heated at extremely high temperature to form clinkers. The lime and shale clinkers are then mixed with a small amount of gypsum and ground very finely to form rapid hardening cement. The difference of rapid hardening cement to that of OPC is the quantity of limestone (tri-calcium silicate) used as raw material, which gives high early strength to the cement.

Rapid Hardening Cement has several benefits:

- RHC has a lower drying shrinkage rate as most of the water is used up for the hydration process. As a result, it creates fewer pores in concrete structures. Therefore, cracks do not form and moisture can't hamper the RCC structures.
- RHC has higher resistance against chemical attacks like sulphate. Hence, the structure attains high durability and requires less repair work.
- In the construction industry, time is money. RHC achieves sufficient stiffness and hardens in a shorter period. Therefore, it ensures faster construction.
- RHC requires less curing time than OPC. So, it implies that finished construction work will need less water, less care, and less money.
- Less carbon-di-oxide is emitted during the production process of RHC in comparison to OPC. Therefore, RHC is more environment-friendly.
- Again, in the dry process of production, less fuel and less heat are required. Therefore, the manufacturing process of RHC is economical.

Even though Rapid Hardening Cement has supremacy over OPC, it has some disadvantages too. They are given below-

- For water retaining or underwater structures like dams and dikes, RHC should not be used. RHC is a hydraulic cement that emits a high amount of heat for hydration reaction. This rapid hydration process in contact with an enormous amount of water can create shrinkage cracks. In the long run, this can cause rust in reinforcement and reduce the longevity of the concrete structure.
- In mass concreting of large concrete structures, RHC should be avoided as it creates a large amount of heat. Therefore, cracks are created because of the huge difference in heat in the internal and external parts of the structure.
- The cost of the RHC is 10% higher than OPC. Therefore, it is expensive to use.

Rapid hardening cement is currently mainly used in prefabricated concrete construction, road works, etc.

Quick Setting Cement

The mechanism of function of aluminium sulphate is that it increases the rate of hydration of tricalcium silicate (C3S) and tricalcium aluminate (C3A) phases of cement.

As the name suggests, **Quick Setting Cement** sets earlier than Rapid Hardening Cement. At the same time, the rate of gain of strength is similar to Ordinary Portland Cement, while quick hardening cement gains strength quickly. Formworks in both cases can be removed earlier.

This special type of cement is used where the setting time of the cement is to be less and hardening of cement is to be fast. The cement clinkers are ground with aluminium sulphate, which accelerates the setting time of cement. Aluminium sulphate is used as an accelerating admixture in the dosage range of 1% to 3% by weight of cement clinkers. The mechanism of function of aluminium sulphate is that it increases the rate of hydration of tricalcium silicate (C3S) and tricalcium aluminate (C3A) phases of cement, thereby providing earlier heat evolution and strength development. It acts as a catalyst in the hydration of tricalcium silicate (C3S) and tricalcium aluminate (C3A).

Concrete specimens with varying percentage of aluminium sulphate were tested for compressive strength, splitting tensile strength and flexural strength. The results

obtained were compared with results of normal M-20 concrete mix and it was found that maximum increase in compressive strength, splitting tensile strength and flexural strength occurred for Quick Setting Cement concrete at 3 days age and 7 days age. However, there was no considerable increase in compressive strength, splitting tensile strength or flexural strength at 28 days age.

Advantages of Quick Setting Cement:

- Due to its lesser setting time as compared to OPC, fast setting cement can be used in underwater concreting, cold weather concreting, etc.
- Although it has less setting time, the final strength attained is the same as that of OPC.
- Quick setting cement has high resistance towards the water.
- The amount of water required during hydration is also less for this type of cement.

Disadvantages of Quick Setting Cement:

- A major disadvantage of quick

setting cement is that it needs to be placed quickly within its initial setting time. As soon as the concrete paste is prepared, it must be transported quickly, otherwise the paste will start setting. Sometimes, it is difficult to place concrete within 5 minutes.

- Due to the rapid setting, a large amount of hydration heat from cement is emitted, which may lead to the formation of shrinkage cracks. Special care must be taken for the dissipation of heat properly.
- As sulphate is present in fast-setting cement, sulphate attack on reinforcement in concrete becomes more prominent. Hence, it cannot be used in reinforced concrete structures.
- It is expensive when compared to OPC.

Quick Setting Cement is currently mainly used where works are to be completed in a very short period of time and for concreting purposes in static or running water.



BUILD **WITH** **SPEED**

To power a nation's ambition

For competition details,
Visit www.ultratechindianext.com

